

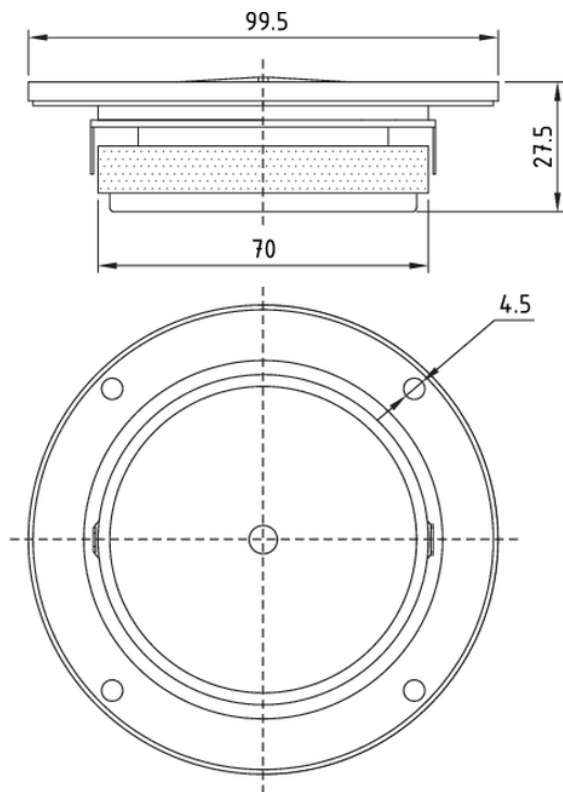

DC25T-8 1" Titanium Dome Tweeter 8 Ohm

DC25T-8



PARAMETERS

Impedance	8 ohms
Re	7.7 ohms
Le	0.59 mH @ 1 kHz
Fs	1468 Hz
Qms	0.58
Qes	2.55
Qts	0.47
Mms	N/A
Cms	N/A
Sd	4.9 cm ²
Vd	N/A
BL	N/A
Vas	N/A
Xmax	N/A
VC Diameter	25 mm
SPL	93 dB @ 1W/1m
RMS Power Handling	50 watts
Usable Frequency Range (Hz)	3,000 - 20,000 Hz

FEATURES

- Great replacement for the Dayton DC25TS-8 1" Titanium Dome Shielded Tweeter

IMPEDANCE/PHASE

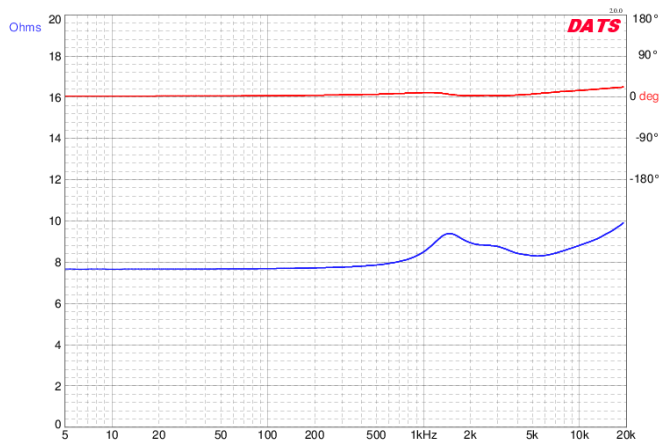

FREQUENCY RESPONSE

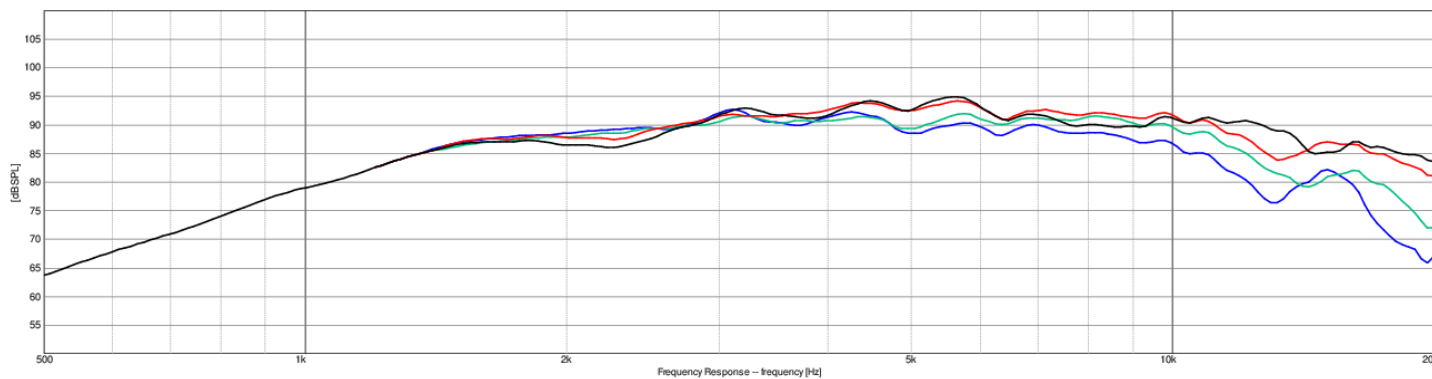

Note: 1/12th octave smoothing - nearfield response included in graph below 450 Hz.

Black = 0°
Red = 15°
Green = 30°
Blue = 45°