

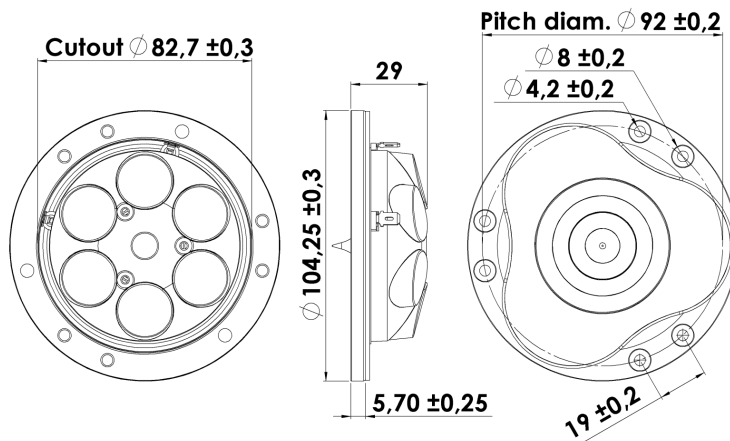

## TWEETER

## R3004/662001

The Illuminator tweeters stand for superb vocal rendition and excellent imaging at all listening locations. With its large roll surround and textile diaphragm provide a flat frequency response to above 30KHz. The unique AirCirc Magnet System, and its rear chamber, results in elimination of reflections and resonances that compromise the performance of traditional motors.



### KEY FEATURES:

- 1" Ring Dome Diaphragm
- Patented Symmetrical Drive (SD-2) motor
- Diffraction Damping Rubber Front
- Patented Phase Plug Design
- AirCirc Motor Design w. 6 Neo magnets
- Die Cast Rubber Painted Alu Face Plate

#### T-S Parameters

Resonance frequency [fs]	520 Hz
Mechanical Q factor [Qms]	3.27
Electrical Q factor [Qes]	0.56
Total Q factor [Qts]	0.48
Force factor [Bl]	2.3 Tm
Mechanical resistance [Rms]	0.30 kg/s
Moving mass [Mms]	0.3 g
Suspension compliance [Cms]	0.31 mm/N
Effective diaph. diameter [D]	27 mm
Effective piston area [Sd]	5.6 cm <sup>2</sup>
Equivalent volume [Vas]	0.01 l
Sensitivity (2.83V/1m)	90.4 dB
Ratio Bl/√Re	1.33 N/√W
Ratio fs/Qts	1094 Hz

#### Notes:

IEC specs. refer to IEC 60268-5 third edition.  
All Scan-Speak products are RoHS compliant.  
Data are subject to change without notice.  
Datasheet updated: February 22, 2011.

#### Electrical Data

Nominal impedance [Zn]	4 Ω
Minimum impedance [Zmin]	3.9 Ω
Maximum impedance [Zo]	20.6 Ω
DC resistance [Re]	3 Ω
Voice coil inductance [Le]	0.03 mH

#### Power Handling

100h RMS noise test (IEC 17.1)*	90 W
Long-term max power (IEC 17.3)*	150 W

\*Filter: 2. order HP Butterworth, 2.5 kHz

#### Voice Coil and Magnet Data

Voice coil diameter	26 mm
Voice coil height	2.1 mm
Voice coil layers	2
Height of gap	2.5 mm
Linear excursion	± 0.2 mm
Max mech. excursion	± 1.6 mm
Unit weight	0.3 kg



# TWEETER

# R3004/662001

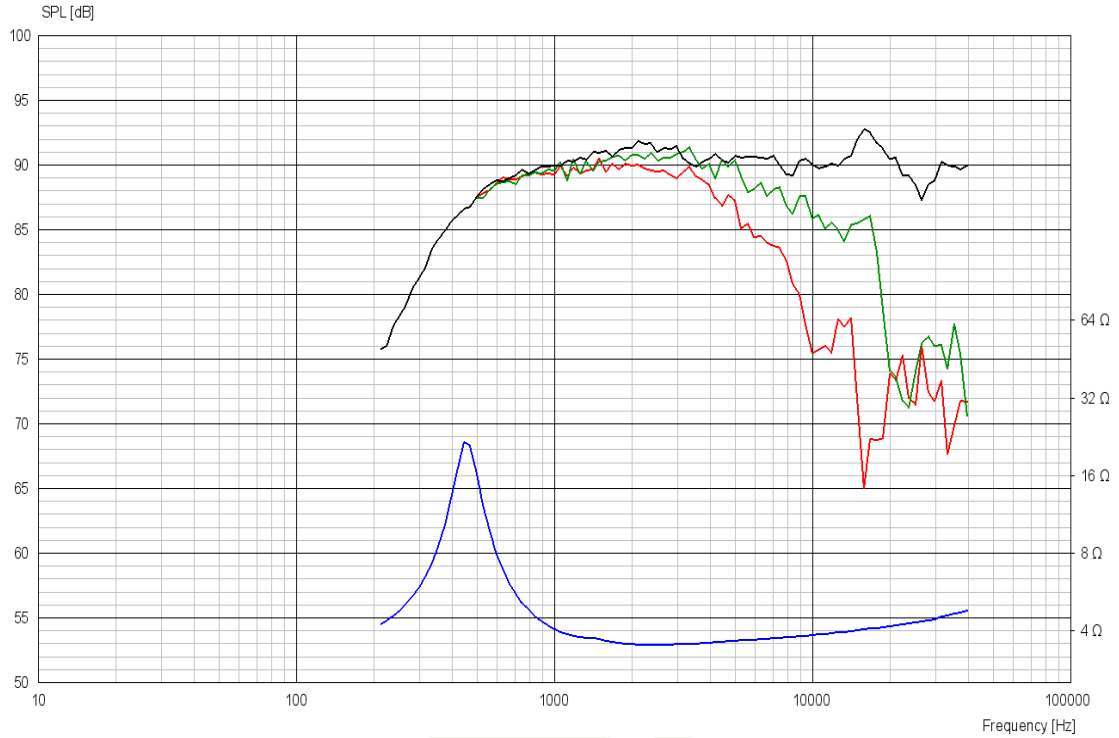

## Advanced Parameters (Preliminary)



### Electrical data:

Resistance [Re']	- Ω
Free inductance [Leb]	- mH
Bound inductance [Le]	- mH
Semi-inductance [Ke]	- SH
Shunt resistance [Rss]	- Ω

### Mechanical Data

Force Factor [Bl]	- Tm
Moving mass [Mms]	- g
Compliance [Cms]	- mm/N
Mechanical resistance [Rms]	- kg/s
Admittance [Ams]	- mm/N